



Det ligger i luften ...



MRF MINI-TAGVENTILATOR



- **Motor og centrifugalhjul afbalanceret for rolig vibrationsfri drift**
- **Montage lodret eller vandret**
- **Leveres med kvadratisk baseplade, som kan afmonteres for montage direkte på rundt ventilations rør**

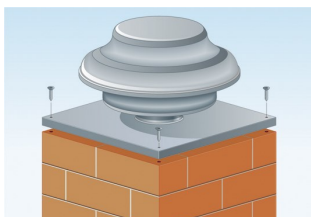

BESKRIVELSE

- Spænding 230 V ~ 50Hz
- Tæthed IP X5
- Motor med vedligeholdelsesfrit **kugleleje** for konstant drift
- Ren luft -20° C til +60° C
- Hætte i modstandsdygtig Aluminium
- Hætten kan afmonteres for adgang til motor og el-tilslutning
- Hættens skruer i rustfri stål
- Kabinet underdel i galvaniseret stål
- Selvrensende bagud kurvede blade
- Sikkerhedsgitter i galvaniseret stål
- Kan tilsluttes hastighedsstyring for maksimal ydelse og økonomisk flow
- Opfylder ErP direktiv 2009/125/EF og UE forordning 1253/2014.



Ventilation. Ikke røgsugning!

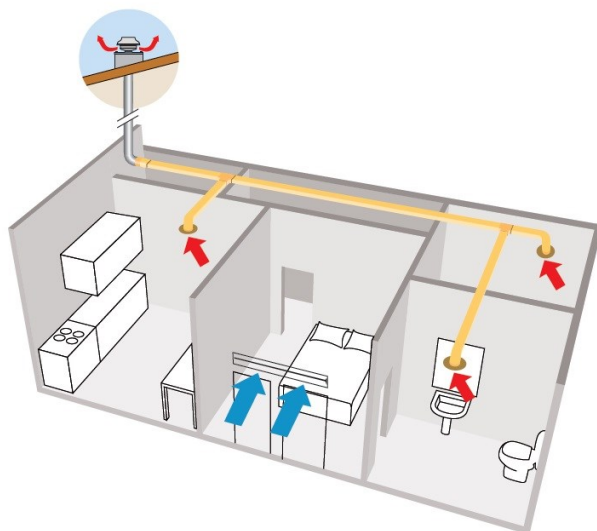
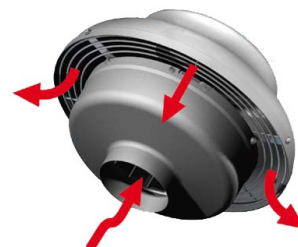

Anvendelses eksempler:

- **Forsamlingslokaler**
- **Sommerhuset**
- **Udestuen**
- **Garagen**
- **Parcelhuset**
- **Værksted**
- **Lagerlokale**
- **Toiletbygninger**

MÅLSKITSE

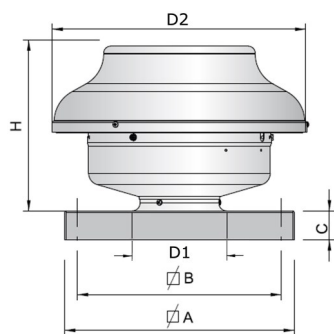

MÅLSKEMA I MM

Model	D1	D2	H	∅A	∅B	C	Kg
MRF 100 BA	98	333	225	300	265	36	4,6
MRF 125 BA	122	333	225	300	265	36	4,6
MRF 160 BA	157	405	266	400	360	36	6,2

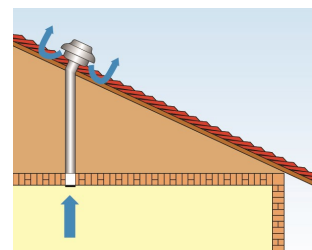
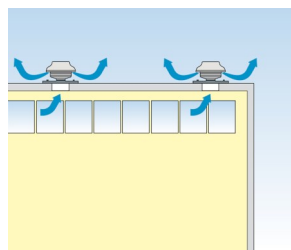
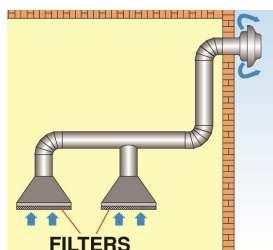
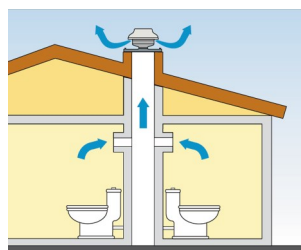

MODTRYKSDIAGRAMMER

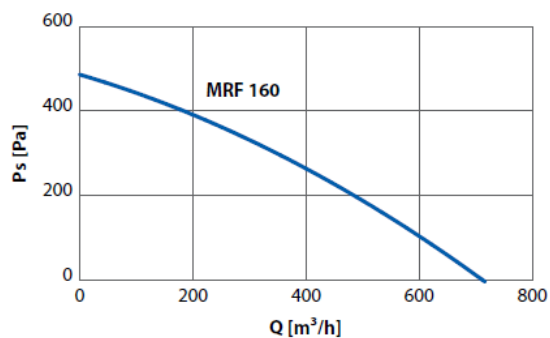
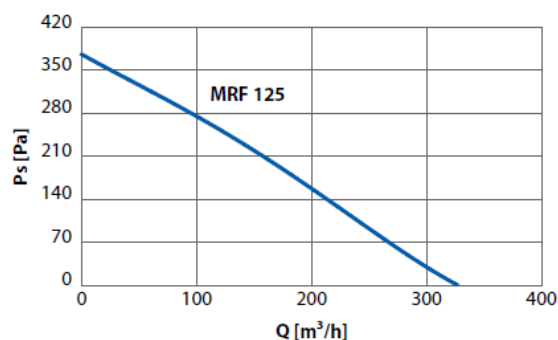
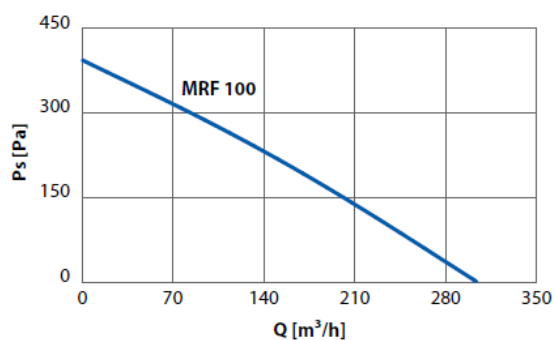

Artikel	Art. nr.	EI.Nr.	VVS Nr.	EAN Nr.	Kapacitet m³/t	Modtryk Pascal	Effekt W	Forbrug A	Lydniveau dB (A) *
MRF 100 BA	2MF1017	9478 086 136	3581 31100	8 0165100 0196 5	318	415	74	0,22	52
MRF 125 BA	2MF1264	9478 086 149	3581 31125	8 0165100 0197 2	342	395	75	0,22	52
MRF 160 BA	2MF1613	9478 086 165	3581 31160	8 0165100 0198 9	736	515	116	0,47	54

* Ved 3 meter frit areal